

LOW PROFILE GRANDEMAX - RIGHT EXIT - 42" AUTOMATIC FLATBREAD PRESS, STAND, OVEN & DUAL DTL

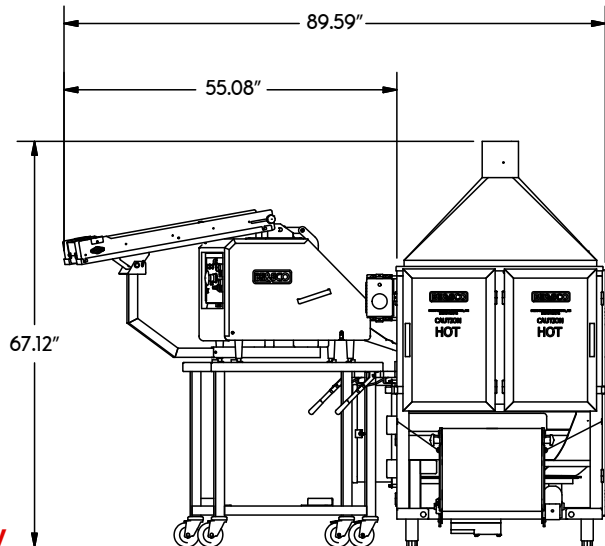

AUTOMATIC

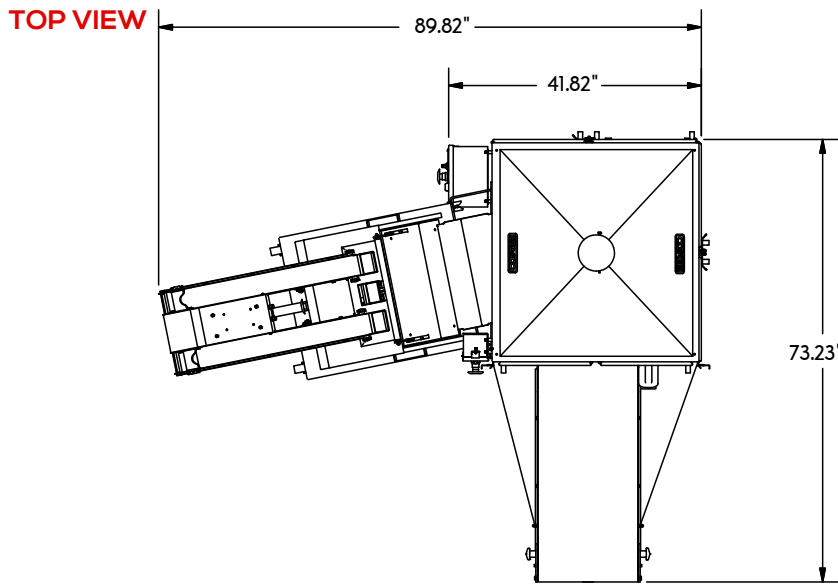





HIGH PRODUCTION



CALIBRATED TO YOUR RECIPE



DIAMETER FROM 4" TO 10"

PRESS VOLTS	220V/240V	OVEN VOLTS	240V
PRESS AMPS	37.5	OVEN AMPS	3
PRESS CYCLES	60HZ	OVEN POWER (GAS)	100000 BTU/HR
PRESS POWER	9000 WATTS	OVEN ELECTRICAL (240V)	 PLUG: NEMA 6-20P (250V~)  RECEPTACLE: NEMA 6-20R (250V~)
PRESS ELECTRICAL	 PLUG: NEMA 10-50P (250V~)  RECEPTACLE: NEMA 10-50R (250V~)	COMBO WEIGHT	1045LBS.
COMBO DIMENSIONS	89.82" L X 73.23" W X 67.1" H		



*Certifications Applicable to Press and Oven Only. Certifications Not Applicable to Stands.

**Production may vary due to the operator experience, diameter and thickness of product.

BE&SCO EQUIPMENT IS SOLELY INTENDED FOR USE IN A COMMERCIAL FACILITY.



REVISED: 10/21/2022